

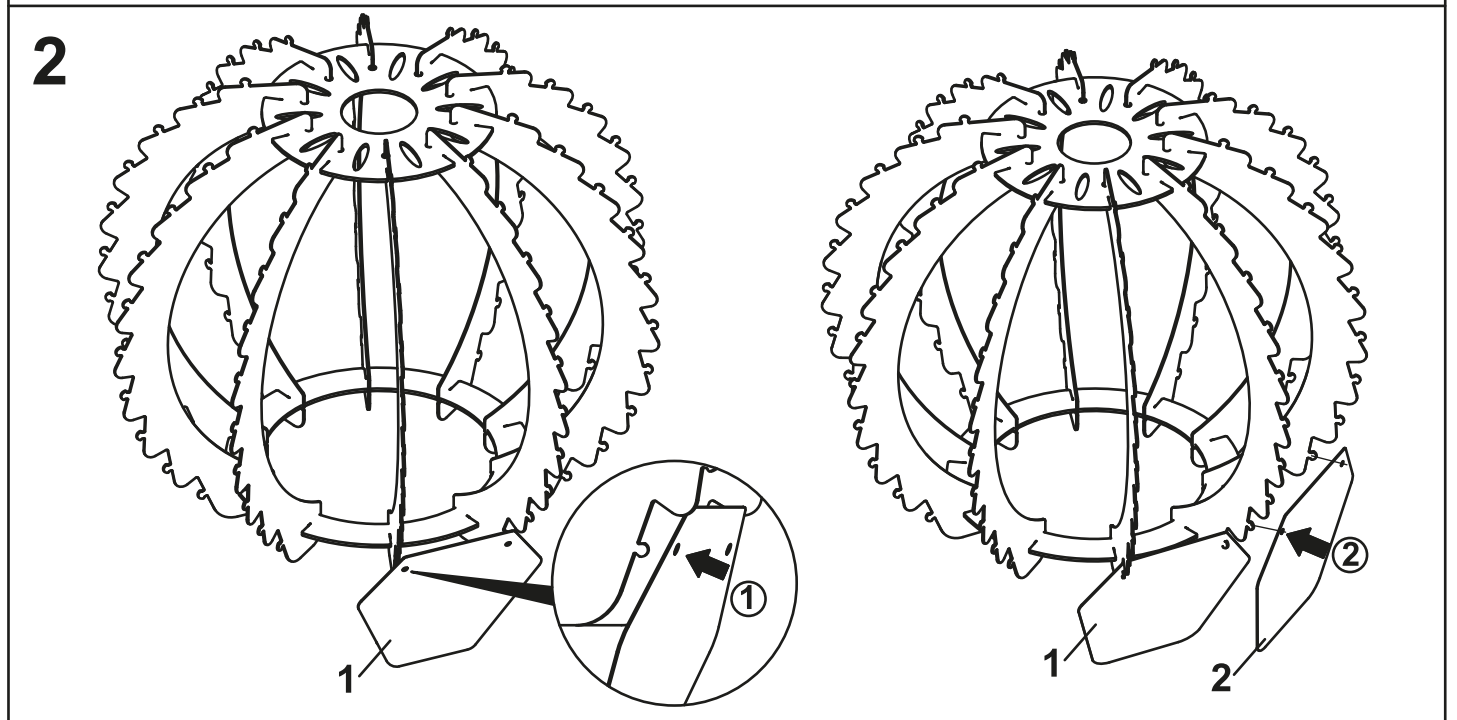

# CARPATICA

## 15337

Aneta

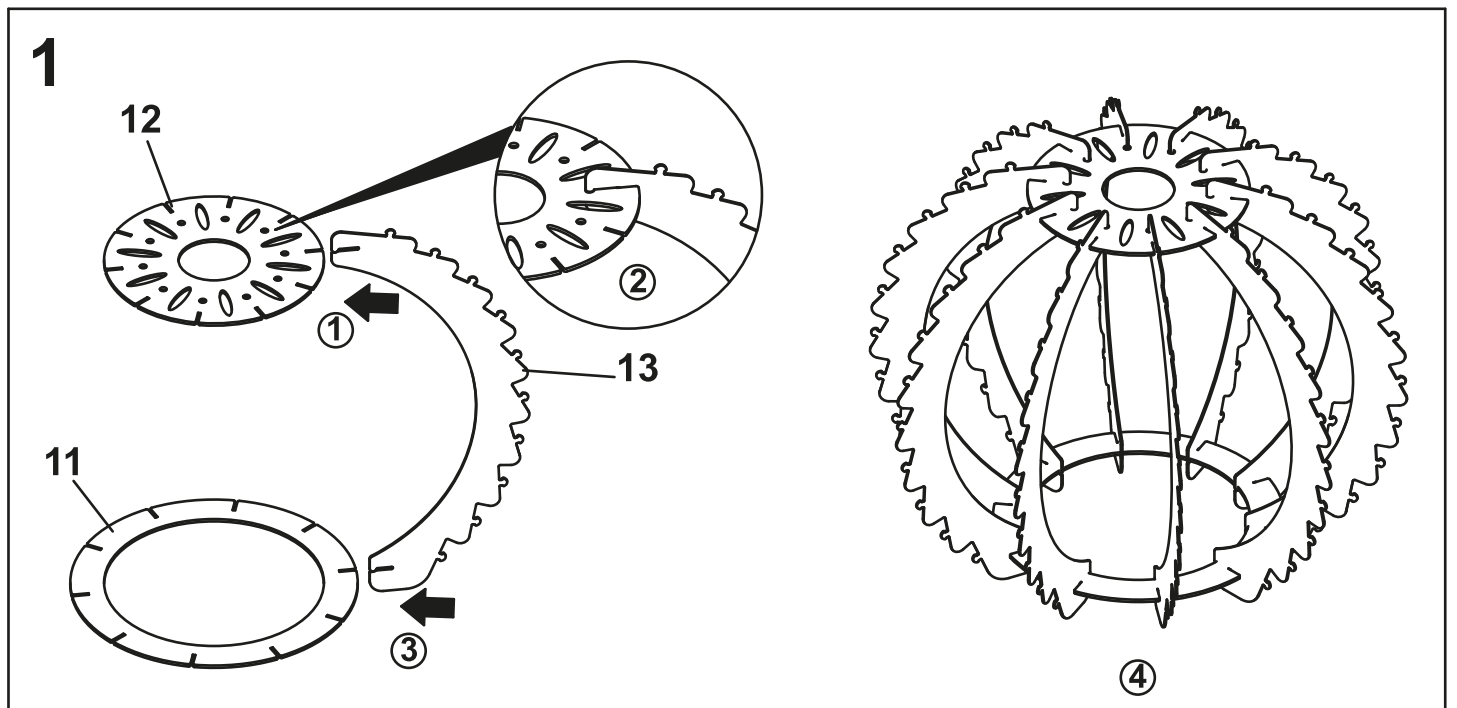
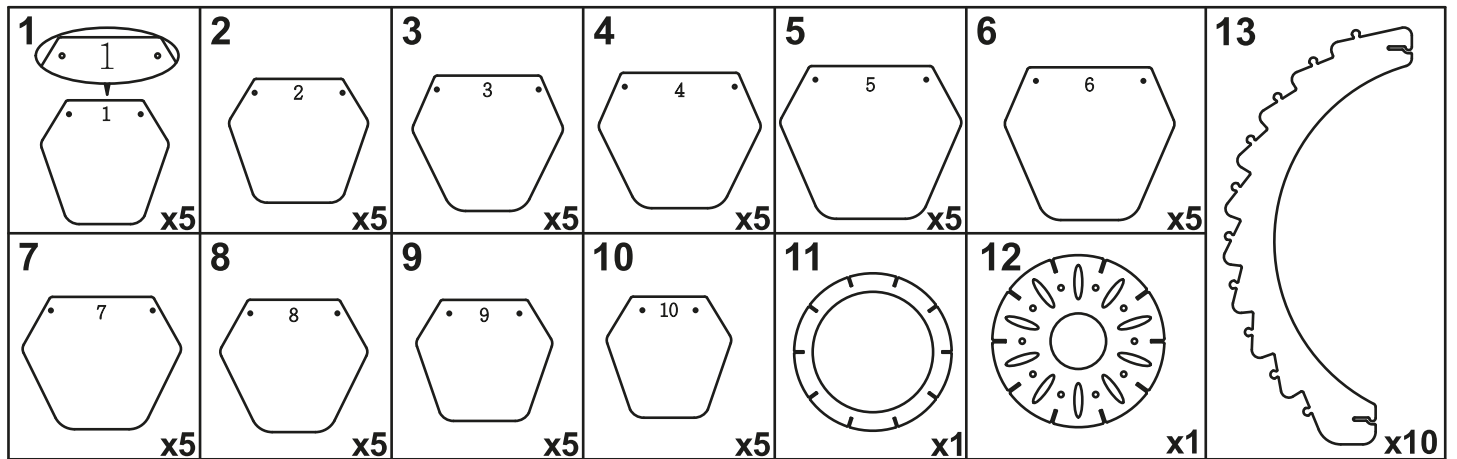

3

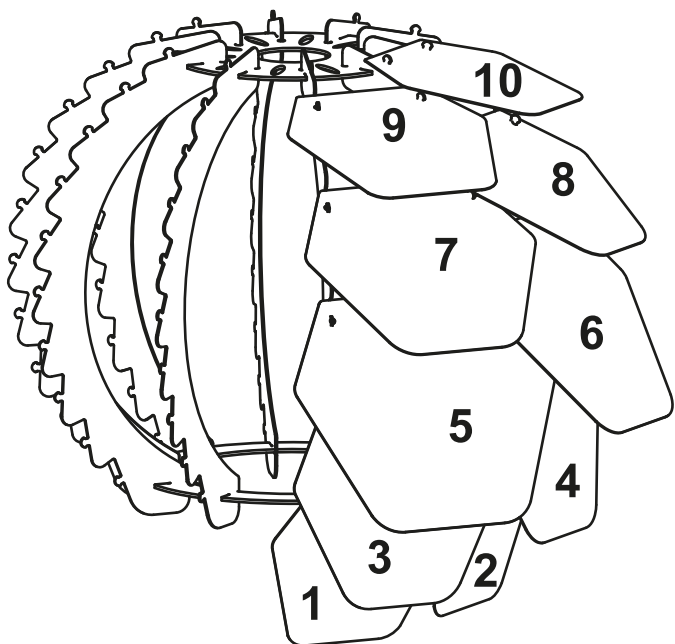

4

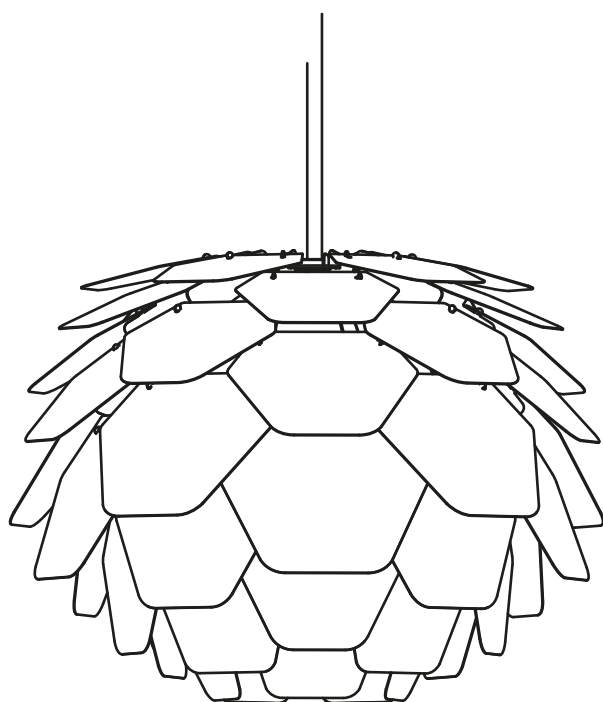
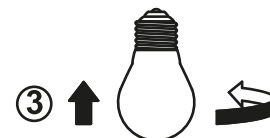
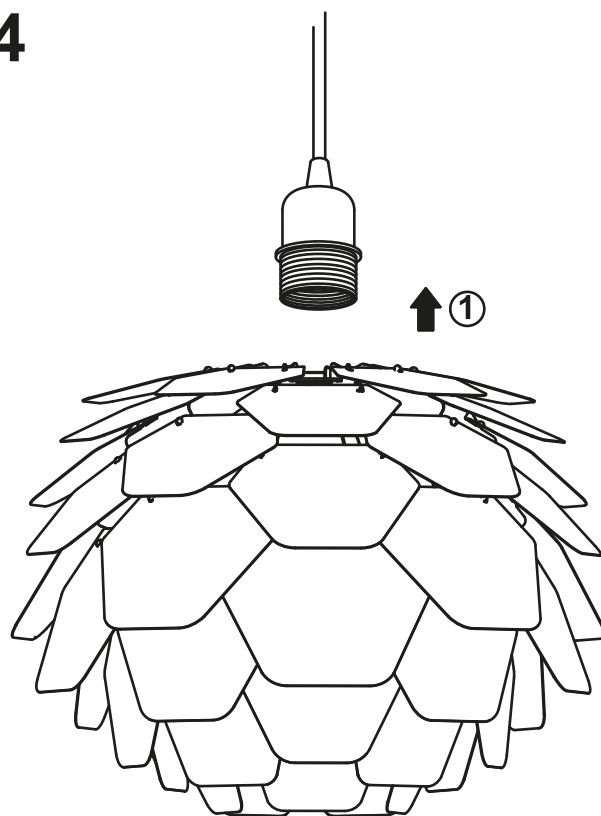

MAX. 60W